

MINIOVEN 05

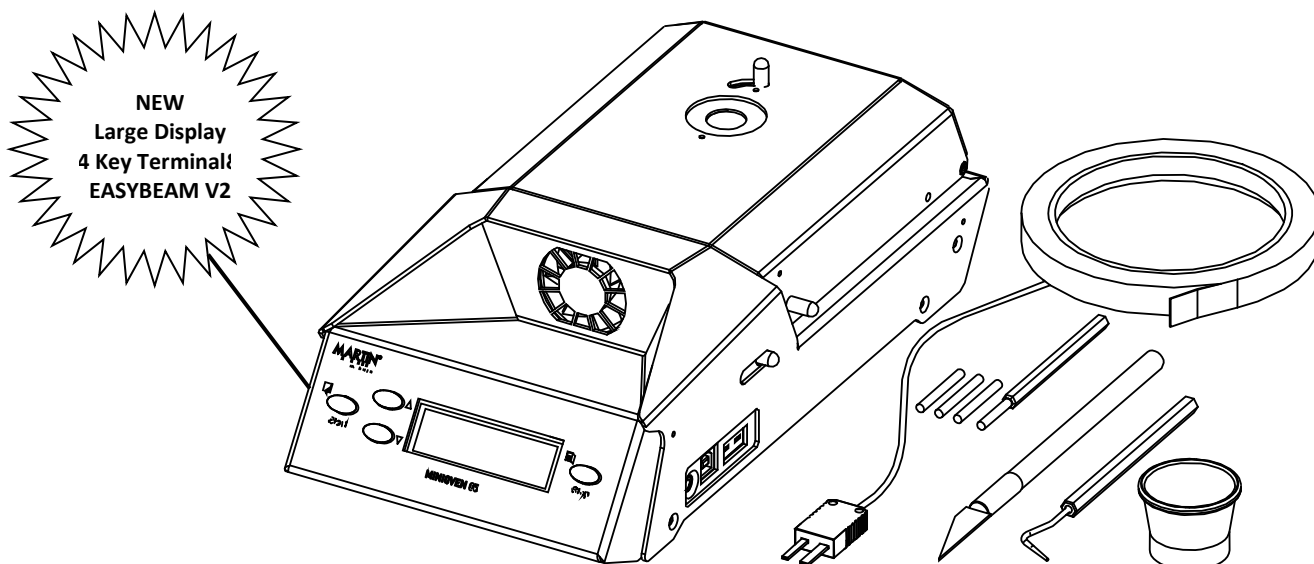

HB00.0025 MINIOVEN 05

The MINIOVEN 05 is a compact and robust table-top device specially designed for reballing of BGAs and prebumping of QFN components. Its highly efficient hybrid heating technology heats-up the electronic components like in a standard reflow oven: Gentle and simultaneously from all sides and guarantees repeatable process results with high yield. MINIOVEN 05 is perfect for use in both production and R&D environment.

The large display and the 4 button front panel layout enable fast set-up and administration of up to 25 reballing profiles which can be saved in the device. Profiles can be taught with the devices auto profiler software. For highest confidence of teaching procedure, the MINIOVEN 05 device use readings from a second temperature sensor which is connected to the oven and attached next to BGA and measures the IC temperature. An inlet for use of process gasses like i.e. nitrogen is factory pre-set.

The free of charge PC software EASYBEAM V2 can be used to download profiles, i.e. for back-up and upload of reballing profiles i.e. from a production server easily. EASYBEAM V2 connects via USB to the MINIOVEN 05 and also may display temperature plots of the two sensors and allows optimization of profile parameter to fit user expectations perfectly.

Aside of a wide range of tooling and accessories for BGA re-balling, holders, fixtures and stencils for QFN pre-bumping are available too. Stencils for a wide selection of QFN components are available from shelf.

Basic Equipment





- MINIOVEN 05 Base Unit
- Sensor for temperature (K-Type)
- Cutter Knife
- SMD Hook
- Cleaning pen with three spare inserts
- Capton tape
- Magnifier
- Power cable
- Manual

Technical Data



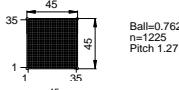
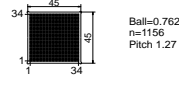
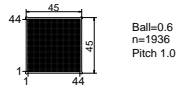
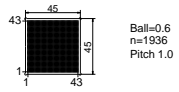
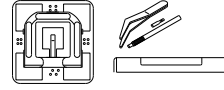

System power consumption:	550 VA
Power heater:	500 W, 4 x IR-Lamps
Size heater:	105 x 130 mm ²
Number of Temperature Sensors:	1 x internally inst. & 1 x external opt.
Number of profiles:	25 entries on device
Rec. max. component Size:	55 x 55 x 4 mm ³
Mains:	1 Phase, 230 VAC
System dimensions:	150 x 300 x 85 mm ³

MINIOVEN 05

Application Sets

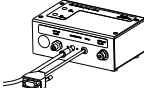
LW50.9001	Reball-04 Set eco Standard		1 set
LW40.0236	Reballing Fixture BGA 45*45mm for MO-04/05 4 downholder clips		Part of set
LW40.0500	Reballing Frame Set BGA for all (98%) types of BGA, 7 pieces		Part of set
LW40.0543	Reballing Mask BGA 45*45mm n=1225 / Pitch=1,27 / Grid=35*35 / Ball=0,762		Part of set
LW40.0686	Reballing Mask BGA 45*45mm n=1156 / Pitch=1,27 / Grid=34*34 / Ball=0,762		Part of set
LW40.0688	Reballing Mask BGA 45*45mm n=1936 / Pitch=1,00 / Grid=44*44 / Ball=0,6		Part of set
LW40.0687	Reballing Mask BGA 45*45mm n=1849 / Pitch=1,00 / Grid=43*43 / Ball=0,6		Part of set
SF29.0002	Prebump-04 Set QFN		1 set
HB50.0005	Tooling and Fixture for QFN Prebumping printer, holder, squeegee, tweezers		Part of set
LWxx.xx11	Prebumping Mask + Frame QFN Type of standard QFN mask on request	 Maske nach Wahl	Part of set

Options

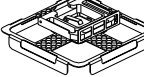
HB00.0112	Switch Box Process Gas for MINIOVEN 05 with connection set	
HB00.4005	Process Gas Connection Set for MINIOVEN 05	
LW40.0251	Reballing Fixture CSP 27*27mm for MO-04/05 Standard	
LW40.0236	Reballing Fixture BGA 45*45mm for MO-04/05 4 downholder clips	
LW40.0237	Reballing Fixture BGA 45*45mm for MO 04/05 with 4 clips and support grid (to be used for PS3)	
LW40.0252	Prebump fixture with printer QFN 27*27mm for MO 04/05	

Consumables

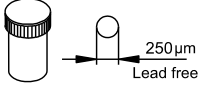
VD90.5104	Solder balls, 50,000 pc, leadfree CSP Sn96.5Ag3Cu0.5 250µm (=3g)	
VD90.5101	Solder Balls, 50,000 pcs., lead free BGA Sn96,5Ag3Cu0,5 762µm (=86g)	
HT00.0009	Flux Pen lead free 0405 C, no clean, RELO	